



boardprep

5 Circuit Road Westmead 3608 | Tel: 031 700 3187
 Fax: 031 700 3781 | www.boardprep.co.za

2 DOOR WALL UNIT

ASSEMBLY INSTRUCTIONS

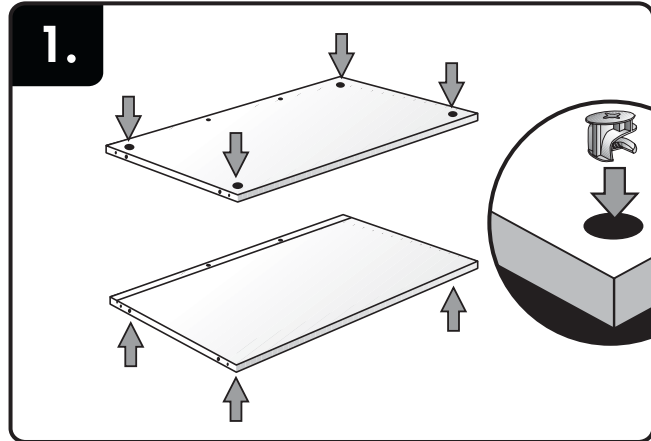

Place cam locks in pre drilled holes.
 (See assembly hints on last page)

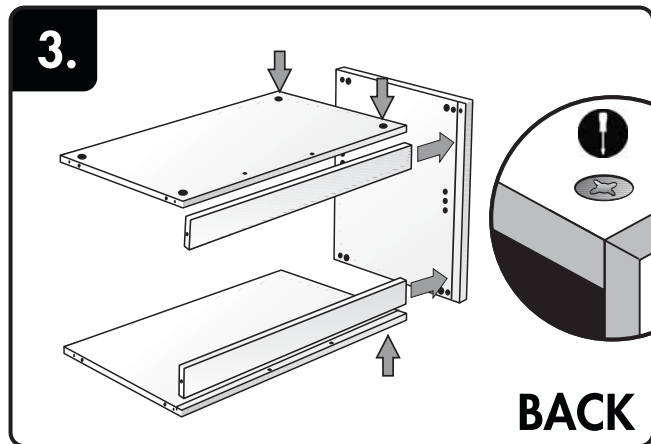

Join side panel and support rails then fasten cam locks.

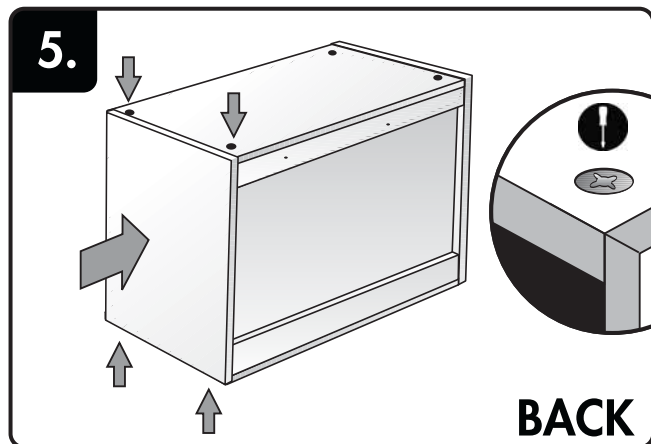

Join second side panel and fasten cam locks.

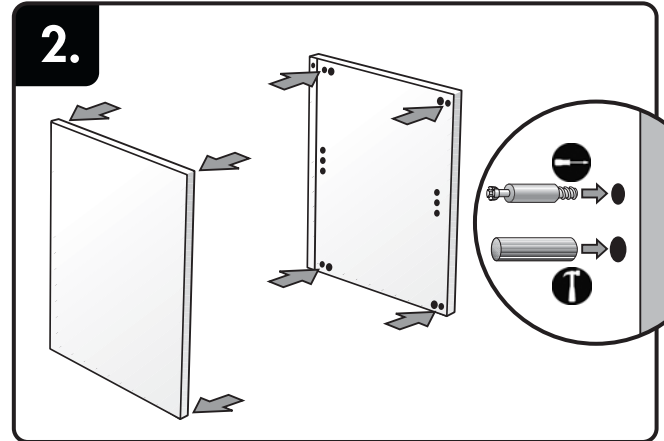
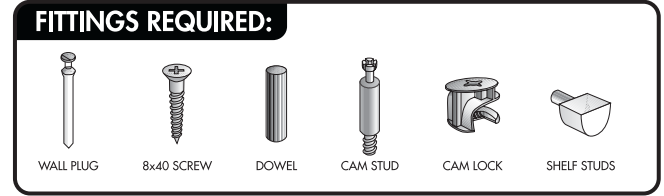
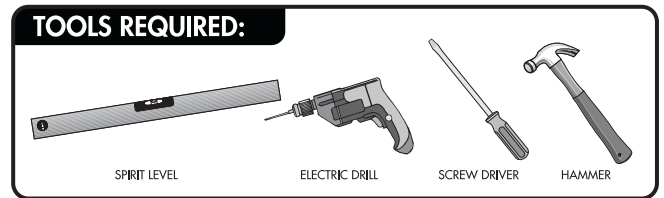

Screw studs and press dowels into pre drilled holes
 In side panels.

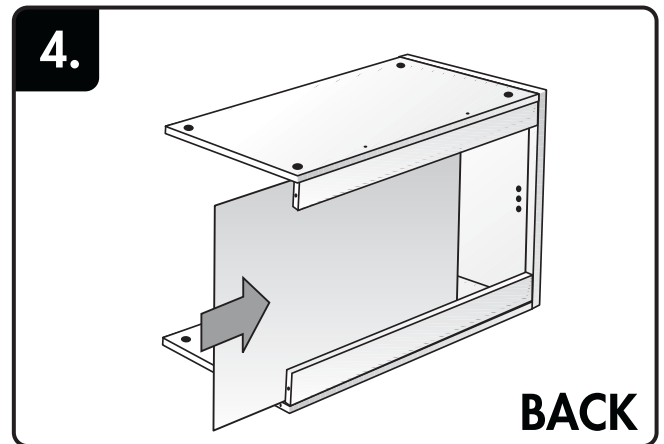

Slide back panel into position ensuring that the finished side is facing inwards.

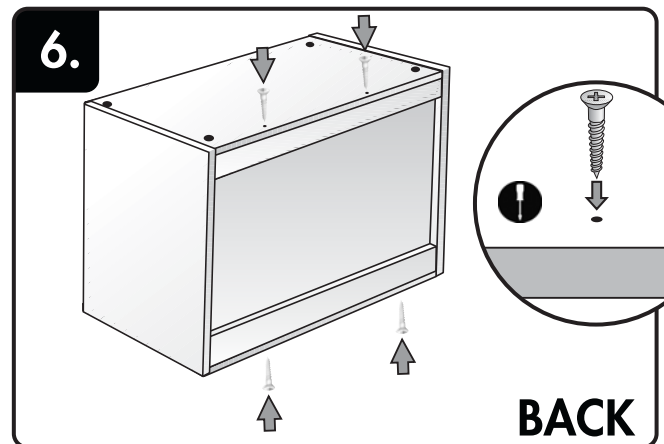

Screw support rails into position using the screws provided.

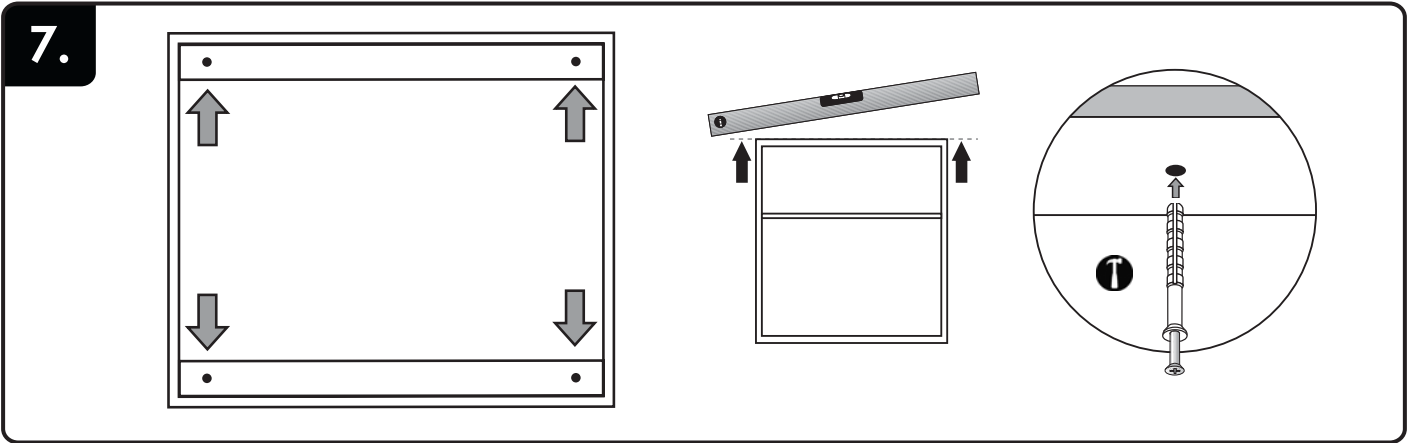

Place the cupboard in its final position and drill 4 holes for wall plugs – 2 go through the top rail into the wall and 2 in the bottom rail. Insert the wall plug into the holes, and hammer into place. Always use a spirit level to ensure cupboard is level when fixing it to the wall.

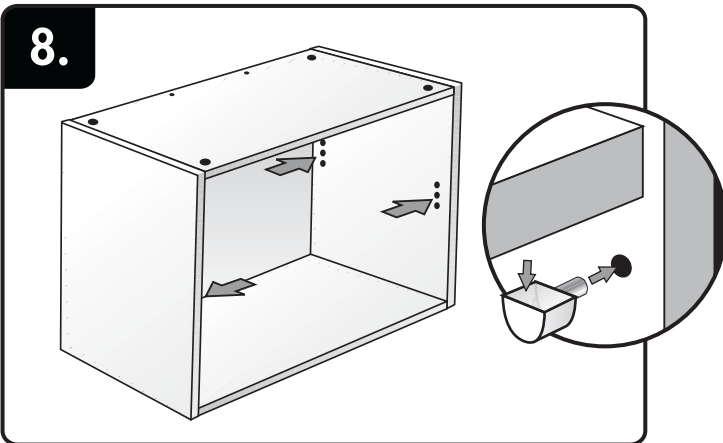

Insert shelf studs into the side panels.

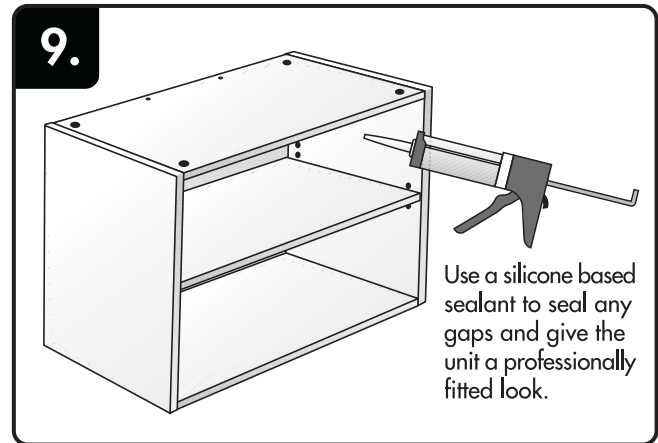

Insert shelf. Unit is complete.

ASSEMBLY HINTS AND TIPS: Using Cam Locks -



1. Place cam locks in pre drilled holes.



2. Screw studs and press dowels into pre drilled holes in side panels.



3. Join panels, inserting studs and dowels into the corresponding holes.

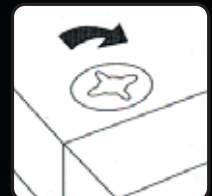

4. Tighten cam locks in a clockwise direction.